



Assembled Vinyl Fence Panel Installation Instructions

Items Needed to Complete Installation:

- Selected Illusions® Vinyl Fence Style
- Selected Illusions® Vinyl Post (V44__ , V55__ or V88__)
- Concrete Post Mix
- Post Cap Style
- Tools
 - Philips Head Power Screw Driver
 - 1/8" Drill Bit
 - Post Hole Digger
 - Level and String Line
 - Tamping Bar
 - Illusions® Vinyl Cap Glue

1-800-339-3362 • www.IllusionsFence.com

Sections - Illusions Styles of Fence Selection

Shown are the different *Illusions*[®] Vinyl Fence Series Styles available. This covers all styles available within the series. Please consult your Illusions Vinyl Fence Catalog to see the individual style choices.

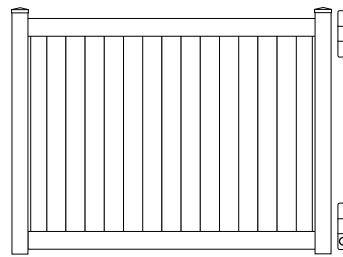

V300 Series (3' to 6' Height)

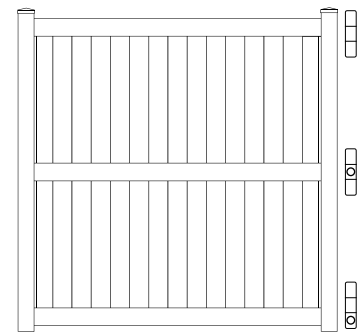

V300 Series (7' to 8' Height)

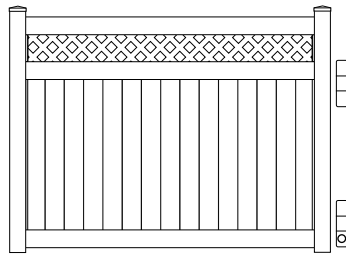

V3215 Series (3' to 8' Height)

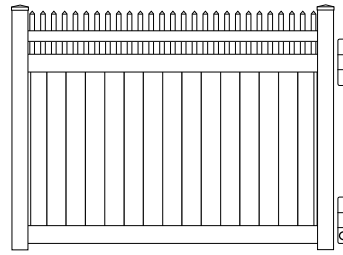

V3700 Series (3' to 8' Height)

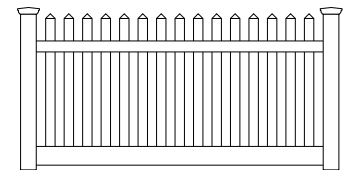

V401 Series (3' to 6' Height)

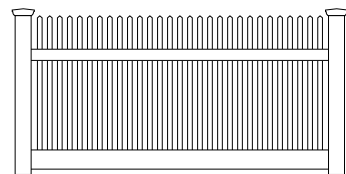

V700 Series (3' to 6' Height)

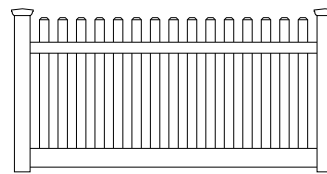

V350 Series (3' to 6' Height)

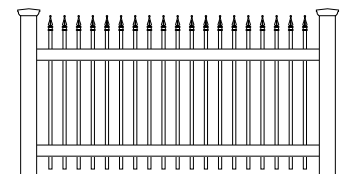

V0100 Series (3' to 6' Height)

**GALVANIZED U-CHANNEL
CORRECT RAILING
PLACEMENT**



○ = Included with Section

Vinyl Posts

4" x 4" Posts

V44__ Series Posts *Illusions*[®]
4" x 4" for all styles up to 6ft. height fence.
Select the end, line, or corner style post to be 3ft. longer than section installed 2" above top of section height.

5" x 5" Posts

V55__ Series Posts *Illusions*[®]
5" x 5" for all styles up to 6ft. height fence.
Select the end, line, or corner style post to be 3ft. longer than section installed 2" above top of section height.

5" x 5" Posts

VH55__ Series Posts *Illusions*[®]
Heavy Wall 5" x 5" for all styles up to 6ft. height fence. Used for heightened wind locations and gate posts.

8" x 8" Posts

V88__ Series Majestic 8" Posts *Illusions*[®]
Heavy Wall 8" x 8" for all styles up to 10ft. Height fence and selection. The end, line, or corner style posts to be 3-4ft. longer than the section installed 2" above the top section height. Recommended for installations in high wind areas as well as Majestic Entrancesways.

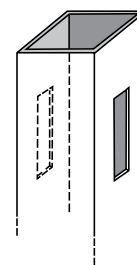

Line

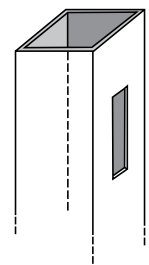

End

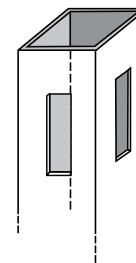

Corner

IMPORTANT NOTE:

Installer must consult local code officials for compliance to building code requirements.

Illusions® Installation (IMPORTANT: Make sure you have accompanying Installation Sheet for Style being installed)

PLANNING

- Prior to construction, check with your local regulatory agency for special code requirements in your areas.
- Contact your utility supplier to locate and mark underground lines.
- Sketch out the layout of your fence and calculate the number of panels, gates, posts and caps needed for your project. Adjust layout to accommodate as many full panels as possible. If you must use a partial panel, place in the furthest corner of the property. (If using cut section, order extra vinyl u-channels, Code# - V7816U).
- Careful planning and measuring of your fence project is essential, as moving posts after the concrete sets is extremely difficult.

DIGGING POST HOLES

- String your line from end to end turning at corners. This will enable a straight line of fence.
- It is recommended to dig one hole at a time. Dig post holes 10" to 12" in diameter and 36" to 42" deep (depending on local ordinance or expected frost depth in winter). (See Figures 1 & 2). The hole should be as deep as the post depending on grade. No less than 30" below grade for 5" x 5" posts and 32" for 8" x 8" posts. The diameter of the hole should be no less than 12" for 5" x 5" posts and 15" for 8" x 8" posts (See Figures 1 & 2). A premium wet or dry concrete mix is to be used depending on ground condition in the area. (Check local codes for amount of concrete to be used).
- Space post holes on center measurements based on the style you'll be installing (See appropriate style spec sheet). Use a string line to ensure all post holes are in line and verify spacing between holes. **Double-check all measurements!**

SETTING & INSTALLING POSTS AND PANELS

- Snap in the pre-notched, pre-assembled section panel into the post before concrete sets (Figures 3 & 4)
- Repeat process with each section.
- Level sections to desired grade.
- Lastly, use a small amount of Illusions Glue on every selected style post cap and place on top of post.

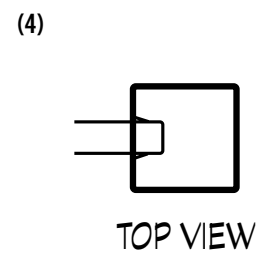
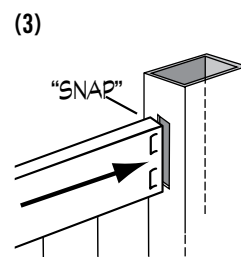
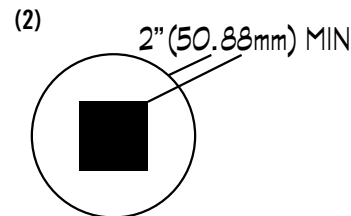
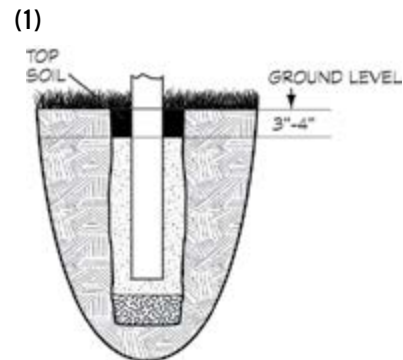
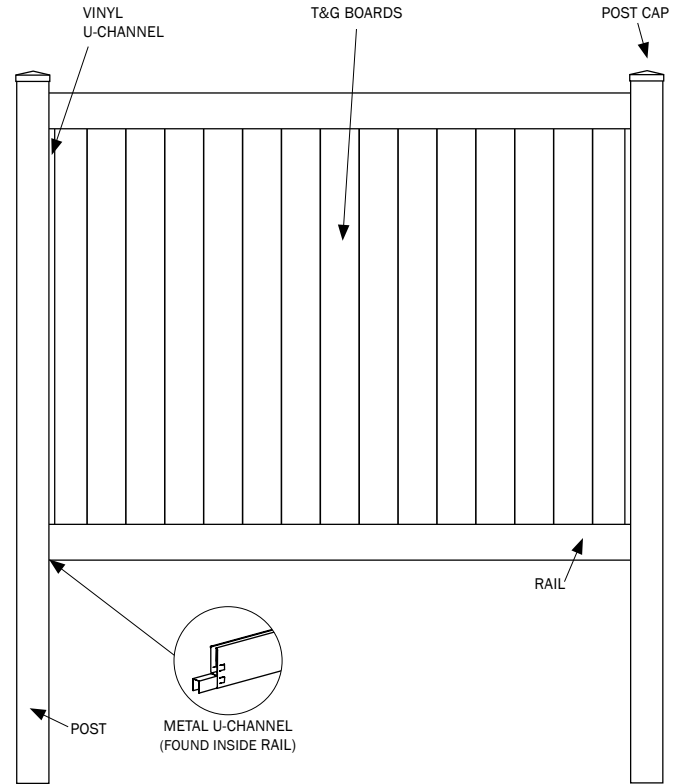

NOTE: In high wind areas, you may want to use 75MPH Wind Illusions Vinyl Fence Certified Adaptor Kits™

Illusions® Material Specifications

NOA# 09-0826.07

Cell Classification - ASTM D4216 1-32333-3

Scope

ASTM F964-13 is considered the “end all, beat all” testing specification for Vinyl fence. The purpose of this specification is to establish a recognized standard of quality for exterior Vinyl profiles for use in assembling agricultural, commercial, and residential fencing and railing. This specification covers **Illusions® Vinyl Fence** sections and the EverStrong® Profiles used to fabricate them.

Materials

Illusions® Vinyl Fence Products are manufactured using Rigid Poly Vinyl Chloride (PVC) compounds for exterior-profile extrusions that meet the requirements of ASTM Specification D4216.

Manufacture

Illusions® Vinyl Fence Products are manufactured to meet cell Class 1-32333-3 as defined in Specification D4216. Illusions® compounds have higher cell classification because one or more properties are superior to those used in standard acceptable compounds.

Color/Consistency Testing – The PVC compound in extruded section shall maintain uniform color and be free of any visual surface or structural changes, such as peeling, chipping, cracking, flaking, or pitting after weathering at intervals of six months and one year for white and for six months, one year, and two years for all other colors in hot, dry climate such as Phoenix, AZ; a hot humid climate, such as Miami, FL; and

a temperate northern climate, when tested in accordance with ASTM Performance Weathering Requirements (TABLE 1).

Weathering Testing – The PVC compound shall have a minimum impact resistance of 0.6 in.-lb/mil (2670 J/m) after weathering six months and one year in a hot, dry climate such as Phoenix, AZ; a hot, humid climate, such as Miami, FL; and a temperate northern climate, when tested in accordance with ASTM Performance Weathering Requirements. The PVC compound shall have successfully met the weathering requirements prescribed for six months at each climatic testing site prior to use in production of exterior-profile extrusions, when tested in accordance with ASTM Performance Weathering Requirements (TABLE 1).

ASTM Specifications Met

D256 – To determine Izod impact properties
D618 – Practice for Conditioning Plastics for Testing
D635 – Test Method for Rate of Burning and/or Extent and Time of Burning of Plastics in a Horizontal Position
D638 – To determine tensile properties
D648 – To determine heat distortion temperature
D696 – Test Method for Coefficient of Linear Thermal Expansion of Plastics Between 030°C and 30°C with a Vitreous Silica Dilatometer
D790 – To determine flexural properties
D792 – To determine specific gravity
D883 – Terminology Relating to Plastics
D1435 – Practice for Outdoor Weathering of Plastics
D1600 Terminology for Abbreviated Terms Relating to Plastics
D1784 – Specification for Rigid Poly (Vinyl

Chloride) (PVC) Compounds and Chlorinated Poly (Vinyl Chloride) (CPVC) Compounds
D1898 – Practice for Sampling of Plastics
D2240 – To determine Shore hardness values
D2244 – Practice for Calculation of Color Tolerances and Color Differences from Instrumentally Measured Color Coordinates
D2565 – Practice for Xenon-Arc Exposure of Plastics Intended for Outdoor Applications
D4216 – Material Class Number 1-32333-3. To establish Cell Classification of PVC material. Illusions compounds have higher cell classification because one or more properties are superior to those used in standard acceptable compounds
D4226 – Test Methods for Impact Resistance of Rigid Poly-(Vinyl Chloride) (PVC) Building Products
D4726 – Specification for Rigid Poly(Vinyl Chloride) (PVC) Exterior-Profile Extrusions Used for Assembled Windows and Doors
E-84-04 – Used to determine the flame spread value of PVC material; Illusions® burn rate is significantly lower than allowed value

Quality Assurance

Illusions® Vinyl Fence Products are run through a series of dimensional and color tests that are performed at least every two hours. Testing includes; flattening, extrusion quality, impact resistance, warp, color comparison with standard color samples, capstock thickness, and bond testing. All will be done at the startup of a production and once per shift thereafter with a minimum of two tests per 24 hours of production.



GET
MORE
INFO ON
YOUR
PHONE



Installation Instructions

1-800-339-3362 • www.IllusionsFence.com