

HYDROGAP® DRAINABLE HOUSEWRAP AND ACCESSORIES

| | Page |
|---|------|
| Basic Installation and Window Flashing: | |
| Pre-Installation Considerations | 2 |
| List of Approved Compatible Products | 3 |
| METHOD I: Modified “O” or “Cut-Back” Method | 4 |
| METHOD II: Modified “I” or “Fold-In” Method | 7 |
| METHOD III: “Windows-First” Method | 10 |
| Details for Stone & Stucco Applications: | |
| Stone & Stucco Assembly Detail | 13 |
| Bottom Detail for Casing Bead | 14 |
| Bottom Detail for Weep Screed | 14 |
| Deck Ledger Flashing Detail | 15 |
| Rigid Foam Details | |
| Option 1 | 16 |
| Option 2 | 17 |
| Option 3 | 18 |
| Innie Window | 19 |
| Outie Window | 20 |

HYDROGAP®
DRAINABLE HOUSEWRAP

HYDROFLASH®
SELF-ADHERED FLASHING

HYDROCORNER™
SILL SOLUTION

Pre-Installation Considerations

- ◆ Flash wall penetrations (such as outlets, exhaust vents, etc.) with proper shingling technique to maintain drainage to the exterior.
- ◆ Flash windows and doors according to building code requirements. Surface should be clean and dry. All self-adhered flashing must be adhered using a foam roller or hand applicator. HydroFlash should be stored inside or in conditioned space prior to installing in cold temperatures.
- ◆ Install windows and doors per manufacturers' installation instructions.
- ◆ Tape all tears and holes that may have been inadvertently introduced during the construction process.
- ◆ HydroGap can be installed in any direction with the spacers facing to the exterior and still maintain its drainage characteristics.
- ◆ Taping of housewrap seams is not recommended unless housewrap will serve as the primary air barrier.
BENEFITS OF NOT TAPING SEAMS:
 - > No reverse flashing introduced into the drainage plane resulting in an unobstructed drainage path
 - > No potential for trapped condensation
 - > Lower cost (as much as 13%)
 - > No impact on warranty coverage by manufacturer
- ◆ When installing HydroGap as the primary air barrier, consider the following:
 - > Tape all seams with HydroFlash 2.5 inch. Surface must be clean and dry and tape must be adhered using a foam roller or hand applicator
 - > Seal the bottom of the first course to the foundation or sill plate using approved sealant.
 - > Seal the top of the last course to the sheathing or top plate
 - > Tape/seal all penetrations and tears. Surface must be clean and dry and tape must be adhered using a foam roller or hand applicator
 - > Use cap fasteners
- ◆ To achieve **15 YEAR PRODUCT AND LABOR LIMITED WARRANTY:**
 - Install with Benjamin Obdyke wall system accessories
 - Cap-fasteners must be used (any brand)
 - HydroFlash must be used as the self-adhered flashing for windows, doors and other penetrations
 - HydroCorner can be used in conjunction with HydroFlash to treat sills.
 - Taping seams of housewrap is optional, but HydroFlash (2.5 inch or wider) must be used if seams are taped

Approved Compatible Products

CLADDING

Fiber Cement
Wood (including Shingles & Shakes)
Vinyl and Insulated Vinyl
Manufactured Stone
Stucco
Metal

FASTENERS

Staples
Cap Fasteners*

SEAM TAPE

Benjamin Obdyke HydroFlash® 2.5in Sealing Tape[^] or
use 4 inch width self-adhered flashing from list below

SELF-ADHERED FLASHING

Benjamin Obdyke HydroFlash®*
3M™ All Weather Flashing Tape 8067
DuPont™ FlexWrap™ NF
ZIPsystem™ Flashing Tape
Protecto Wrap Super Stick
SIGA Wigluv
SIGA Fentrim F
Nichigo G-Tape™ 3040BK

SILL TREATMENT

Benjamin Obdyke HydroFlash®*
Benjamin Obdyke HydroFlash®* with HydroCorner®[^]
SureSill™
Minimum 9 inch width self-adhered flashing from those
listed here under “Self-Adhered Flashing”

CAULKS and SEALANTS

OSI® QUAD® MAX Sealant
Loctite® Premium® construction adhesive
Loctite® PL Premium® S40 polyurethane
GeoCel® 2300 Construction Tripolymer
GeoCel® Pro Flex®
Fortifiber® Moistop® Sealant
Bostik® 915™ polyurethane sealant
Bostik® 915FS™ polyurethane sealant
Dow Corning® 732 multi-purpose sealant
NPC® Solar Seal #900
Titebond® Heavy Duty construction adhesive
Titebond® WeatherMaster™
Titebond® WeatherMaster™ ULTIMATE MP
Tremco® Vulkem® 116
DAP® Flexible CLEAR Sealant

***required components to achieve 15 YEAR PRODUCT AND
LABOR LIMITED WARRANTY**

**^optional components to achieve 15 YEAR PRODUCT AND
LABOR LIMITED WARRANTY**

Basic Installation & Window Flashing: METHOD I - Modified “O” or “Cut-Back” Method

STEP 1

- ◆ Unroll HydroGap Drainable Housewrap with blue spacers facing to the exterior and fasten to sheathing with nails, staples or cap fasteners.
- ◆ Fasteners should provide a minimum 3/8 inch penetration into the nail base and be spaced approximately 12 to 18 inches apart along the horizontal and vertical laps. Fasten every 3 ft elsewhere. **For commercial installation above 40 feet, cap fasteners are recommended.
- ◆ HydroGap Drainable Housewrap should be installed shingle lap fashion (i.e. begin installation at the base of the wall assembly).
- ◆ Extend housewrap a minimum 2 inches over sill plate.
- ◆ Overlap all horizontal seams by at least 4 inches, all vertical seams by at least 6 inches and corners by 12 inches.
- ◆ Be sure that the housewrap installation and flashing provide for positive drainage to the exterior of the assembly.
- ◆ Do not allow the housewrap to be exposed to sunlight in excess of 120 days. Recommended coverage within 30 days.
- ◆ Taping of seams is NOT REQUIRED. (See pg. 2 for further details). Optionally, tape all HydroGap Drainable Housewrap seams with HydroFlash 2.5in. Surface must be clean and dry, and tape must be adhered using a foam roller or hand applicator.

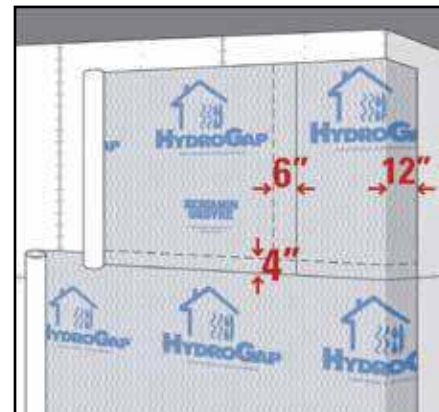

STEP 2

- A.** Wrap the entire building including window and door openings.
- B.** At each window opening, cut housewrap flush with window opening. Then, cut housewrap back 2 inches at each window jamb and sill to reveal sheathing. Cut housewrap at the head 45 degrees away from window opening to account for flashing width.

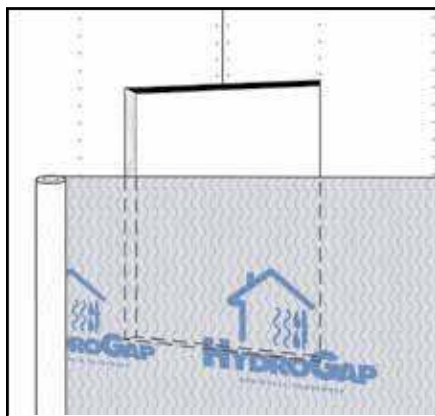

- C.** Fold up top trapezoid shaped “flap” and secure temporarily with tape prior to installing window.

Basic Installation & Window Flashing: METHOD I - Modified "O" or "Cut-Back" Method

STEP 3

A. (Optional) Install sloped sill or back dam (optimal slope 1/4 inch), except when using approved pre-manufactured sill pan.

B. 9 inch or 12 inch wide HydroFlash is recommended for sill installation as pictured in illustrations. If using 6 inch wide HydroFlash, you must use two pieces of HydroFlash at the sill: one piece flush with edge of sill; one piece folded into sill. 4 inch wide self-adhered flashing is not recommended for sill treatment.

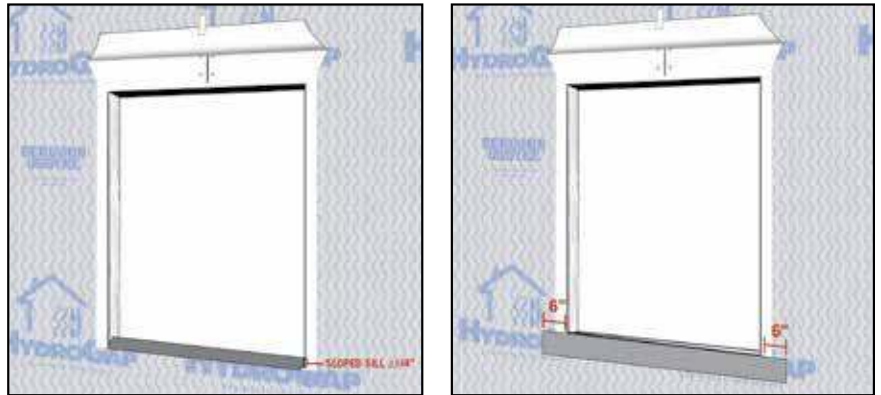

C. To properly flash the sill, cut and install corner patch flashing (STEP 3.D.) or use HydroCorners (STEP 3.E.).

D. Install pre-cut HydroFlash over corner patches. Install HydroFlash to extend at least 6 inches up the side of each jamb inside window opening.

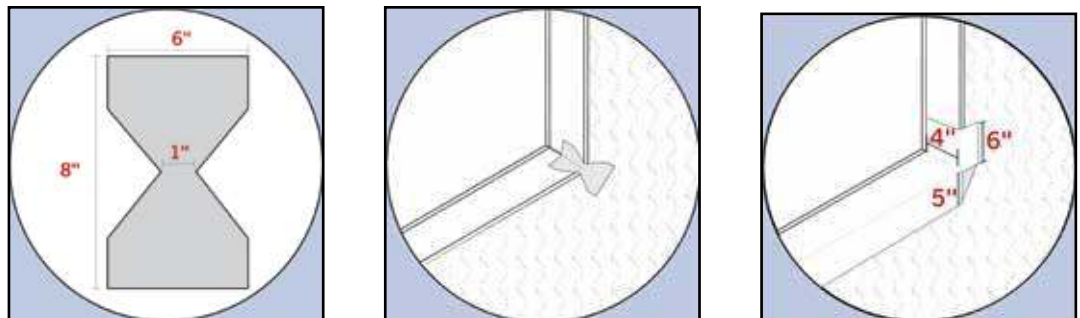

E. To use HydroCorners instead of corner patches, place a HydroCorner in each sill corner and fasten in place with a staple. Install pre-cut HydroFlash over corner patches. Install HydroFlash to extend at least 6 inches up the side of each jamb inside window opening.

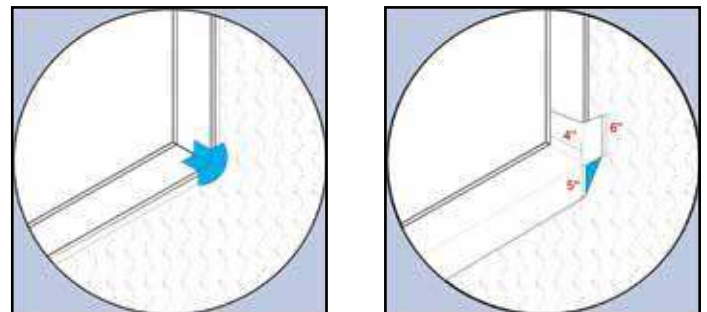

Basic Installation & Window Flashing: METHOD I - Modified “O” or “Cut-Back” Method

STEP 3 (continued)

- F.** Apply caulk/sealant at jambs and head.
- G.** Install flanged window.
- H.** Install HydroFlash to the side jambs. Surface should be clean and dry and self-adhered flashing should be applied using a foam roller or hand applicator.

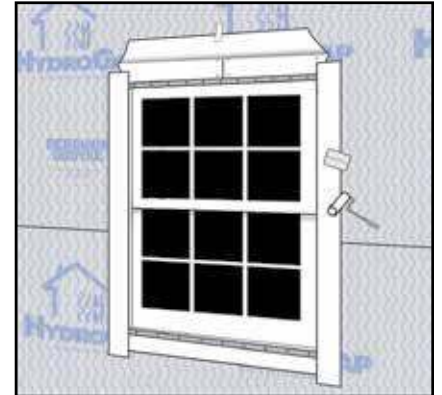
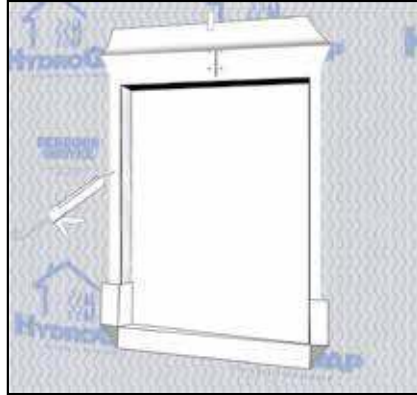

- I.** Install drip cap. Install HydroFlash header flashing. Surface should be clean and dry and self-adhered flashing should be adhered with a foam roller or hand applicator.
- J.** Fold top flap down on top of flashed header and apply HydroFlash at diagonal cuts.

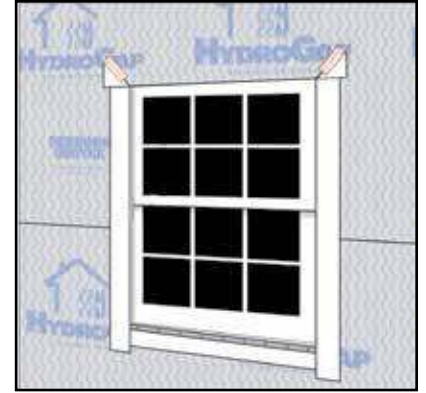
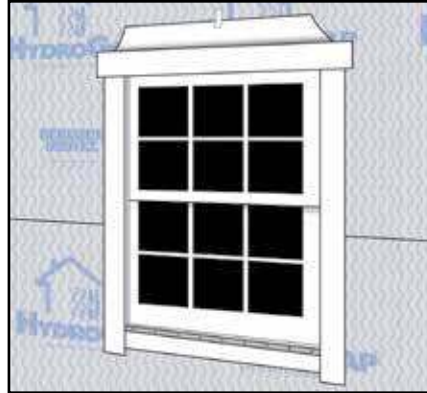

Basic Installation & Window Flashing: METHOD II - Modified "I" or "Fold-in" Method

STEP 1

- ◆ Unroll HydroGap Drainable Housewrap with blue spacers facing to the exterior and fasten to sheathing with nails, staples or cap fasteners.
- ◆ Fasteners should provide a minimum 3/8 inch penetration into the nail base and be spaced approximately 12 to 18 inches apart along the horizontal and vertical laps. Fasten every 3 ft elsewhere. **For commercial installation above 40 feet, cap fasteners are recommended.
- ◆ HydroGap Drainable Housewrap should be installed shingle lap fashion (i.e. begin installation at the base of the wall assembly).
- ◆ Extend housewrap a minimum 2 inches over sill plate.
- ◆ Overlap all horizontal seams by at least 4 inches, all vertical seams by at least 6 inches and corners by 12 inches.
- ◆ Be sure that the housewrap installation and flashing provide for positive drainage to the exterior of the assembly.
- ◆ Do not allow the housewrap to be exposed to sunlight in excess of 120 days. Recommended coverage within 30 days.
- ◆ Taping of seams is NOT REQUIRED. (See pg. 2 for further details). Optionally, tape all HydroGap Drainable Housewrap seams with HydroFlash 2.5in. Surface must be clean and dry, and tape must be adhered using a foam roller or hand applicator.

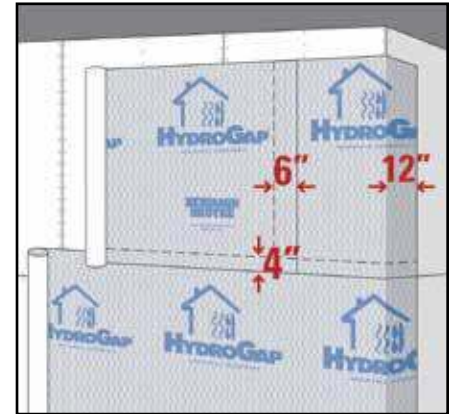

STEP 2

- A.** Wrap the entire building including window and door openings.
- B.** At each window opening, cut an "I" shape into housewrap. Cut housewrap above top corners 45 degrees away from window opening to account for flashing width.
- C.** Fold side flaps into rough opening and cut/fasten.

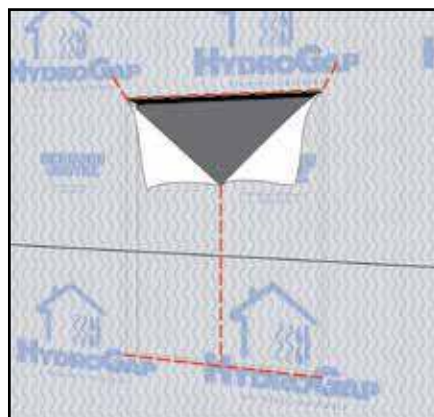
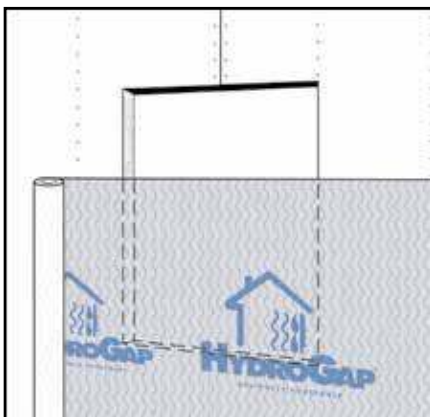

- D.** Fold up top trapezoid shaped "flap" and secure temporarily with tape prior to installing window.

Basic Installation & Window Flashing: METHOD II - Modified "I" or "Fold-in" Method

STEP 3

A. (Optional) Install sloped sill or back dam (optimal slope 1/4 inch), except when using approved pre-manufactured sill pan.

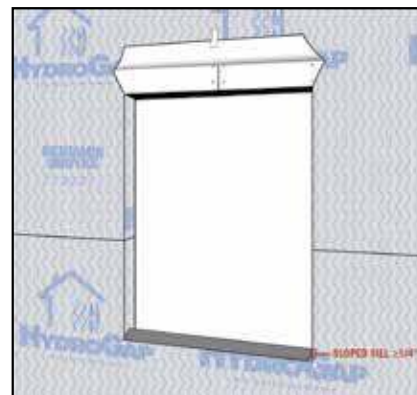

B. 9 inch or 12 inch wide HydroFlash is recommended for sill installation as pictured in illustrations. If using 6 inch wide HydroFlash, you must use two pieces of HydroFlash at the sill: one piece flush with edge of sill; one piece folded into sill. 4 inch wide self-adhered flashing is not recommended for sill treatment.

C. To properly flash the sill, cut and install corner patch flashing (STEP 3.D.) or use HydroCorners (STEP 3.E.).

D. Install pre-cut HydroFlash over corner patches. Install HydroFlash to extend at least 6 inches up the side of each jamb inside window opening.

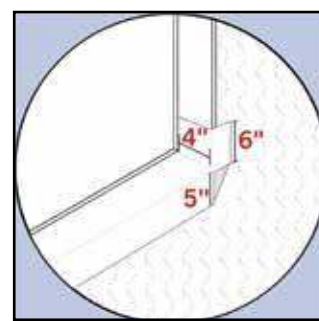
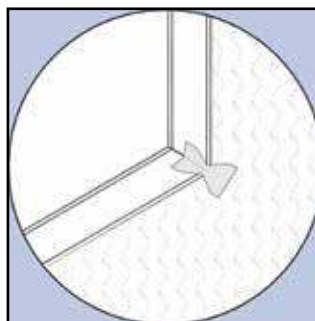
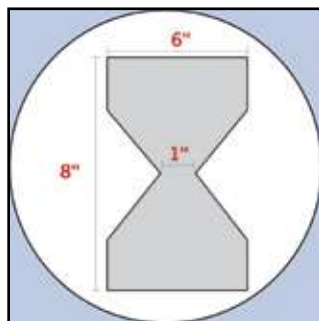

E. To use HydroCorners instead of corner patches, place a HydroCorner in each sill corner and fasten in place with a staple. Install pre-cut HydroFlash over corner patches. Install HydroFlash to extend at least 6 inches up the side of each jamb inside window opening.

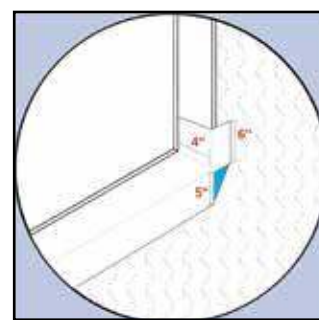
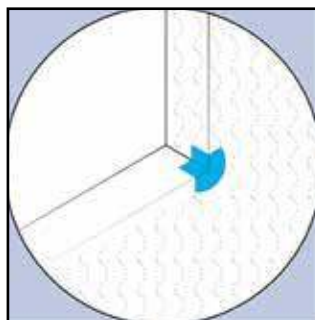

Basic Installation & Window Flashing: METHOD II - Modified “I” or “Fold-in” Method

STEP 3 (continued)

F. Apply caulk/sealant at jambs and head.

G. Install flanged window.

H. Install HydroFlash to the side jambs. Surface should be clean and dry and self-adhered flashing should be applied using a foam roller or hand applicator.

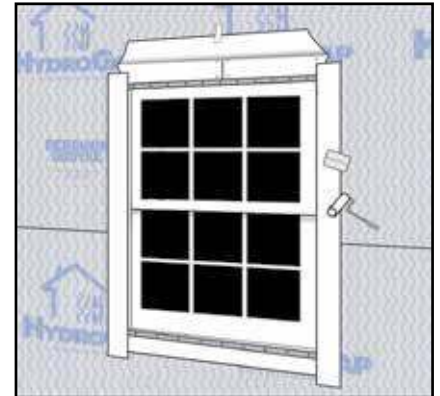
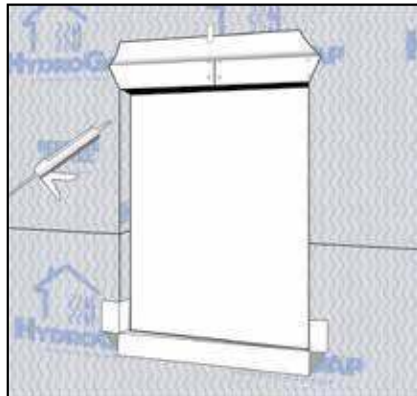

I. Install drip cap. Install HydroFlash header flashing. Surface should be clean and dry and self-adhered flashing should be adhered with a foam roller or hand applicator.

J. Fold top flap down on top of flashed header and HydroFlash at diagonal cuts.

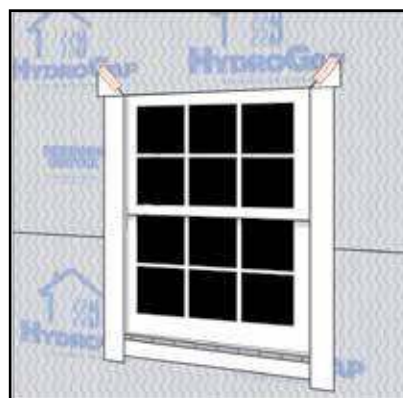

Basic Installation & Window Flashing: METHOD III - "Windows-First" Method

STEP 1

A. Secure a HydroGap "apron" at sill using a piece of HydroFlash. Apron should extend beyond each side of rough opening at least the width of the jamb flashing; not less than 6 inches. Secure apron to the wall along the top edge, but leave the bottom of the apron loose. The loose edge will overlap the layer of HydroGap installed after window installation is complete.

B. (Optional) Install sloped sill or back dam (optimal slope ¼ inch), except when using approved pre-manufactured sill pan.

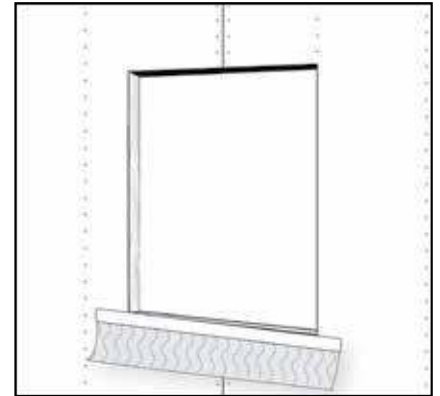

C. 9 inch or 12 inch wide HydroFlash is recommended for sill installation as pictured in illustrations. If using 6 inch wide HydroFlash, you must use two pieces of HydroFlash at the sill: one piece flush with edge of sill; one piece folded into sill. 4 inch wide self-adhered flashing is not recommended for sill treatment.

D. To properly flash the sill, cut and install corner patch flashing (STEP 3.E.) or use HydroCorners (STEP 3.F.).

E. Install pre-cut HydroFlash over corner patches. Install HydroFlash to extend at least 6 inches up the side of each jamb inside window opening.

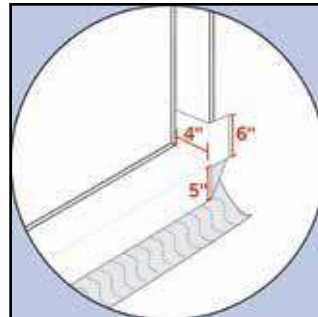
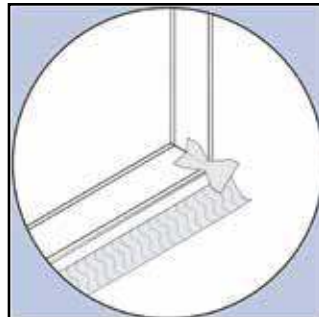
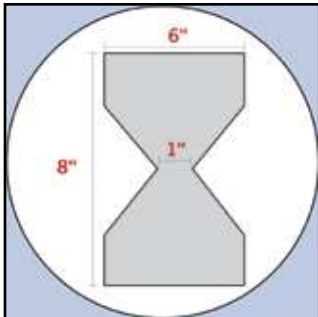

F. To use HydroCorners instead of corner patches, place a HydroCorner in each sill corner and fasten in place with a staple. Install pre-cut HydroFlash over corner patches. Install HydroFlash to extend at least 6 inches up the side of each jamb inside window opening.

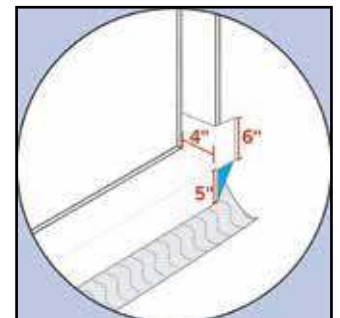
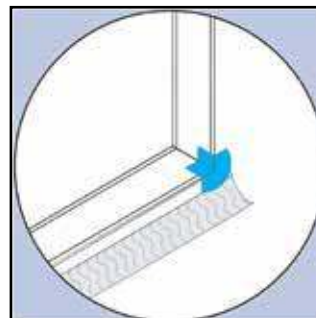

Basic Installation & Window Flashing: METHOD III - “Windows-First” Method

STEP 1 (continued)

F. Apply caulk/sealant at jambs and head. Do not caulk at window sill.

G. Install flanged window.

H. Install HydroFlash to the side jambs. Surface should be clean and dry and self-adhered flashing should be applied using a foam roller or hand applicator.

I. Install drip cap. Install HydroFlash header flashing. Surface should be clean and dry and self-adhered flashing should be adhered with a foam roller or hand applicator.

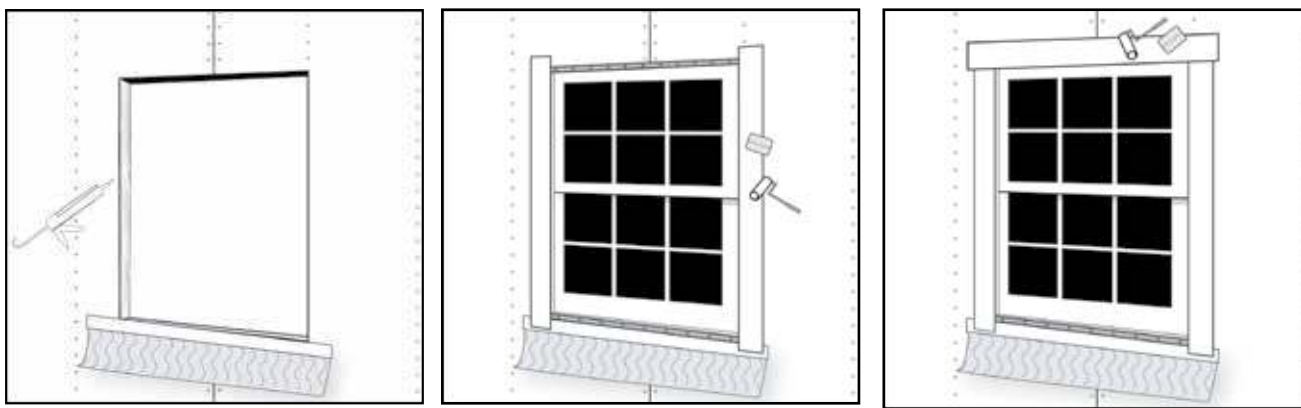

STEP 2

- ◆ Wrap the entire building including windows and doors. Unroll HydroGap™ Drainable Housewrap with blue spacers facing to the exterior and fasten to sheathing with nails, staples or cap fasteners.
- ◆ Fasteners should provide a minimum 3/8 inch penetration into the nail base and be spaced approximately 12 to 18 inches apart along the horizontal and vertical laps. Fasten every 3 ft elsewhere. **For commercial installation above 40 feet, cap fasteners are recommended.
- ◆ HydroGap Drainable Housewrap should be installed shingle lap fashion (i.e. begin installation at the base of the wall assembly).
- ◆ Extend housewrap a minimum 2 inches over sill plate.
- ◆ Overlap all horizontal seams by at least 4 inches, all vertical seams by at least 6 inches and corners by 12 inches.
- ◆ Be sure that the housewrap installation and flashing provide for positive drainage to the exterior of the assembly.
- ◆ Do not allow the housewrap to be exposed to sunlight in excess of 120 days. Recommended coverage within 30 days.
- ◆ Taping of seams is NOT REQUIRED. (See pg. 2 for further details). Optionally, tape all HydroGap Drainable Housewrap seams with HydroFlash 2.5in. Surface must be clean and dry, and tape must be adhered using a foam roller or hand applicator.

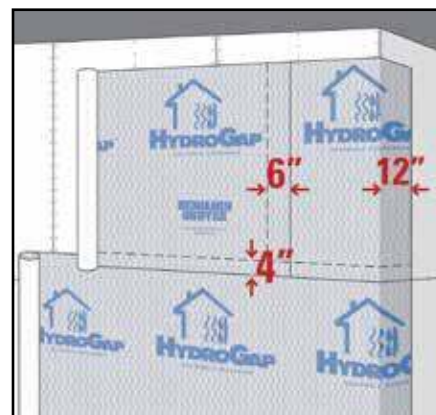

Basic Installation & Window Flashing: METHOD III - “Windows-First” Method

STEP 3

- A.** At window locations, cut back HydroGap to expose window. Do not cut through HydroFlash or HydroGap apron.
- B.** At 2 - 4 inches below window, cut horizontal slit in HydroGap, extending to edges of jamb flashing. Do not cut through HydroFlash or HydroGap apron. Pull apron through to lap over top layer of HydroGap, creating positive drainage.
- C.** Tape seams with HydroFlash at window jambs. Do not tape the top or bottom of window.

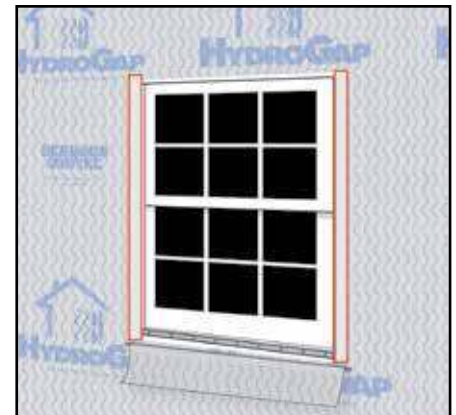
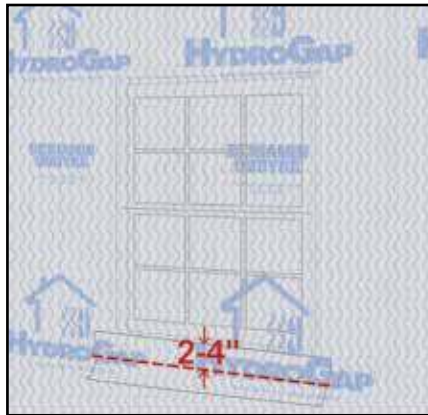

Stone and Stucco Application: Stucco and Stone Assembly

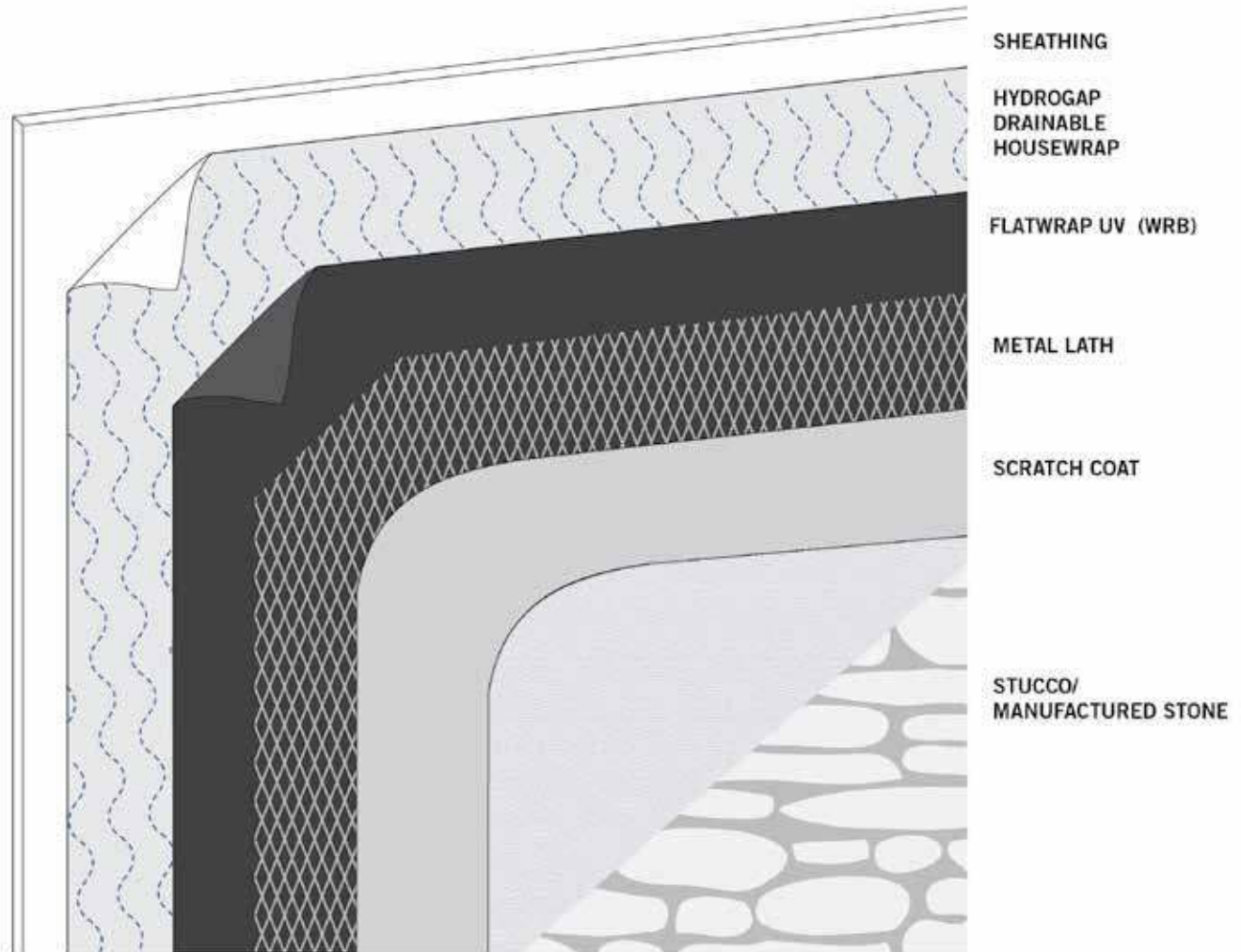

Integrate HydroGap with all sidewall flashing materials.

The second layer of water-resistive barrier (WRB) serves as an intervening layer, or "bond break", with the scratch coat to help maintain the drainage gap.

Stone and Stucco Application: Bottom Detail for Casing Bead

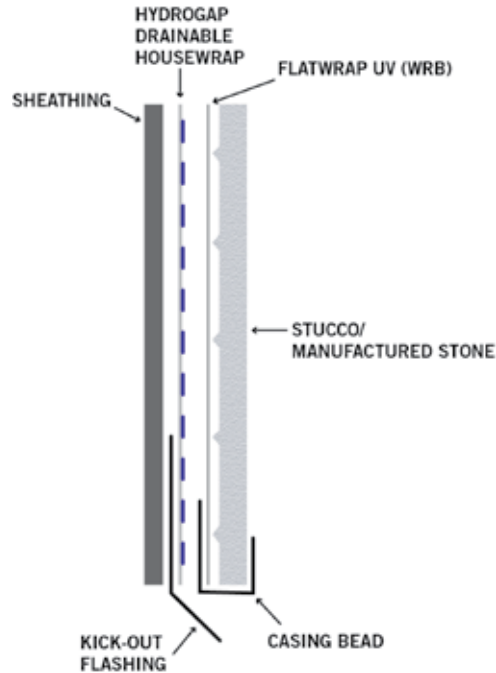

Stone & Stucco Application: Bottom Detail for Weep Screed

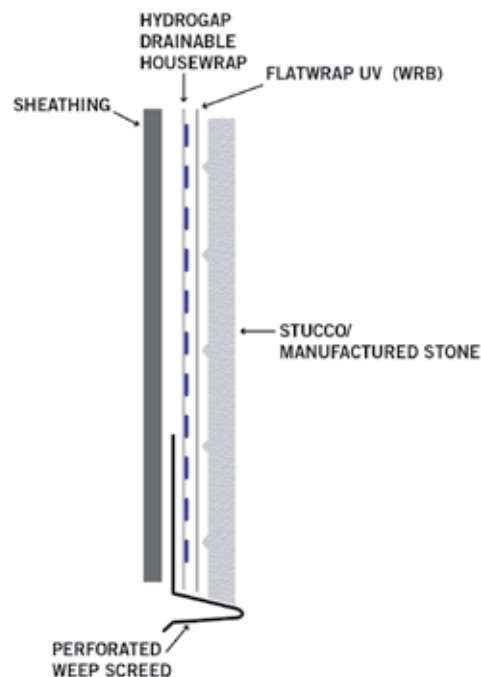

Deck Ledger Flashing Detail

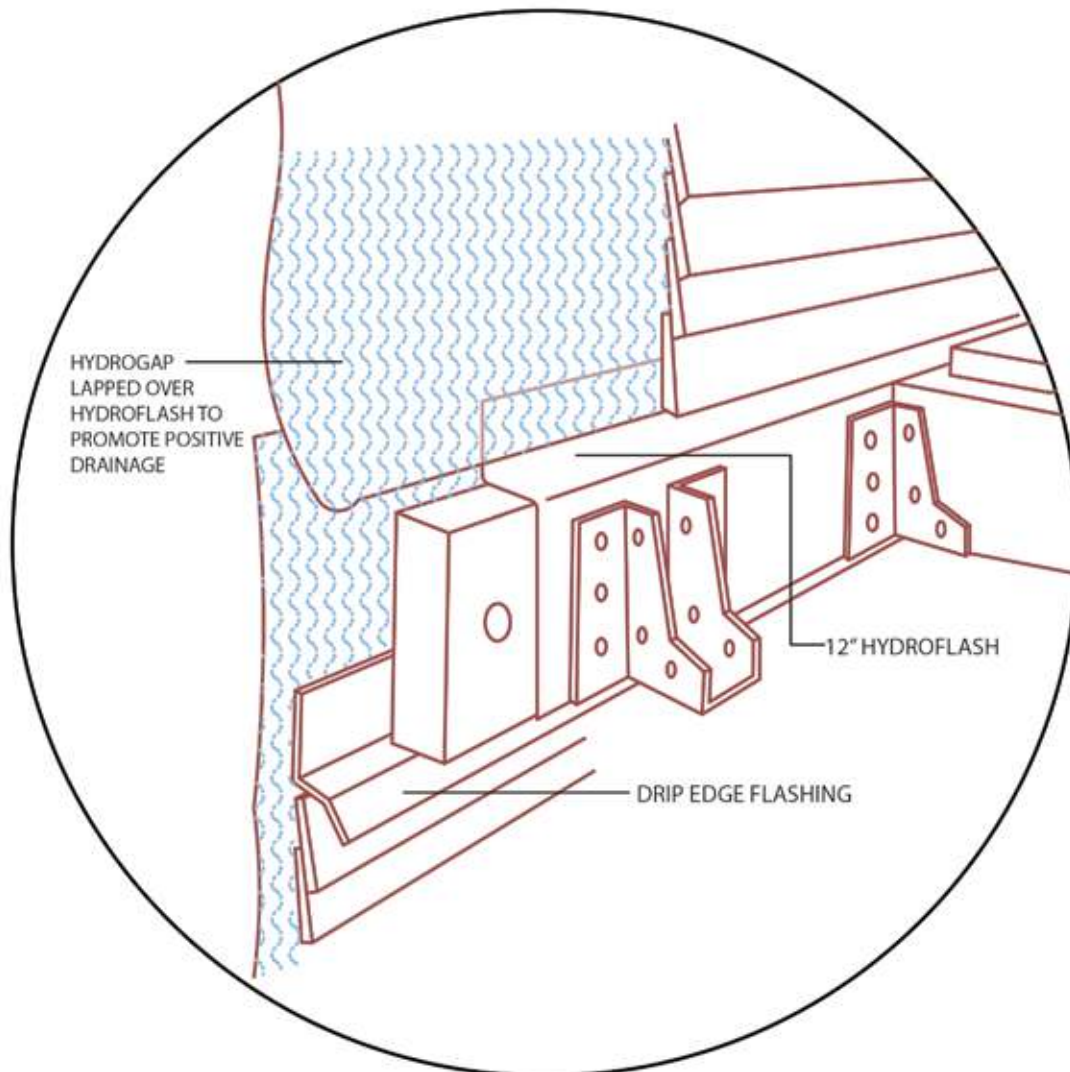

Rigid Foam Applications: Option 1

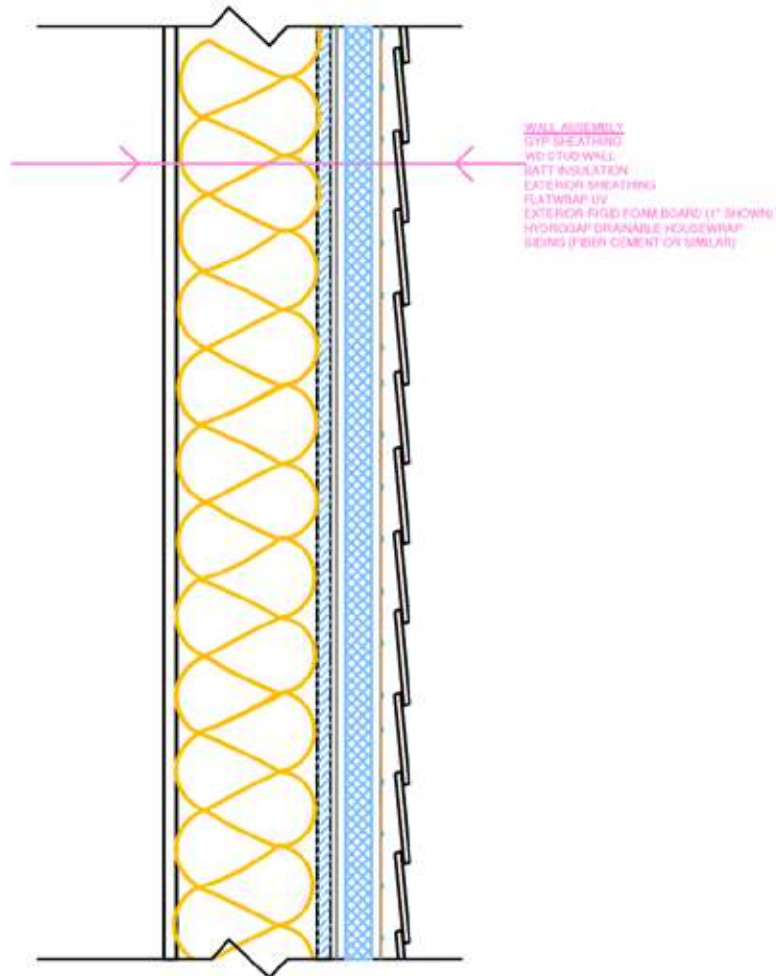

OPTION 1: FLATWRAP UV, RIGID FOAM AND
HYDROGAP

Rigid Foam Applications: Option 2

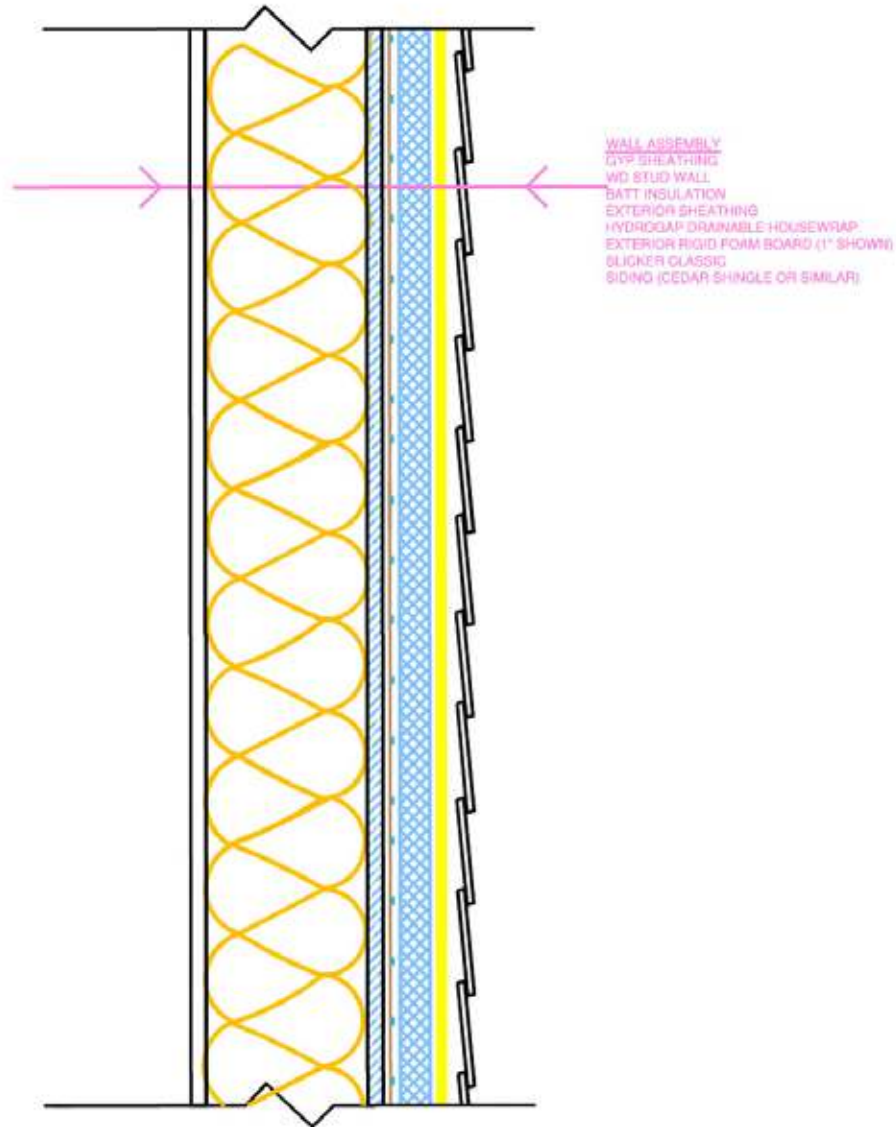

OPTION 2: HYDROGAP, RIGID FOAM,
SLICKER CLASSIC

Rigid Foam Applications: Option 3

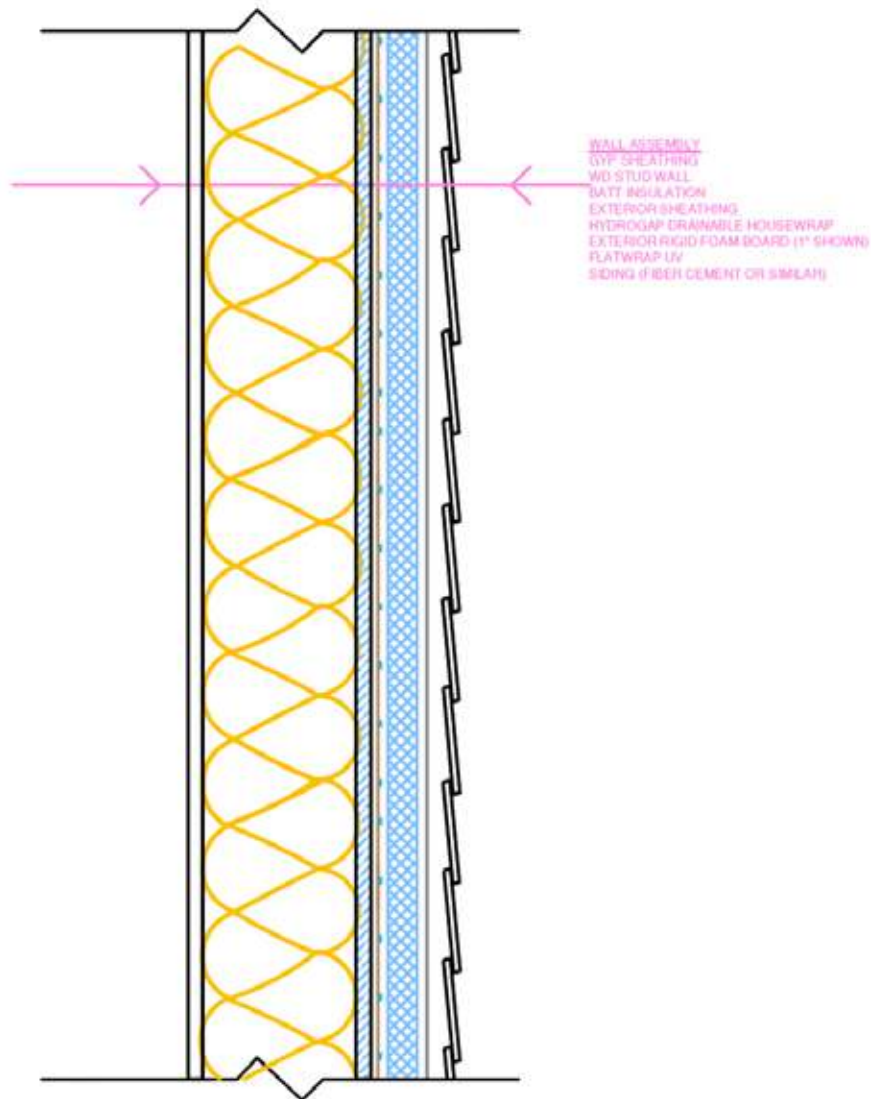

OPTION 3: HYDROGAP, RIGID FOAM AND
FLATWRAP UV

Rigid Foam Applications: Innie Window

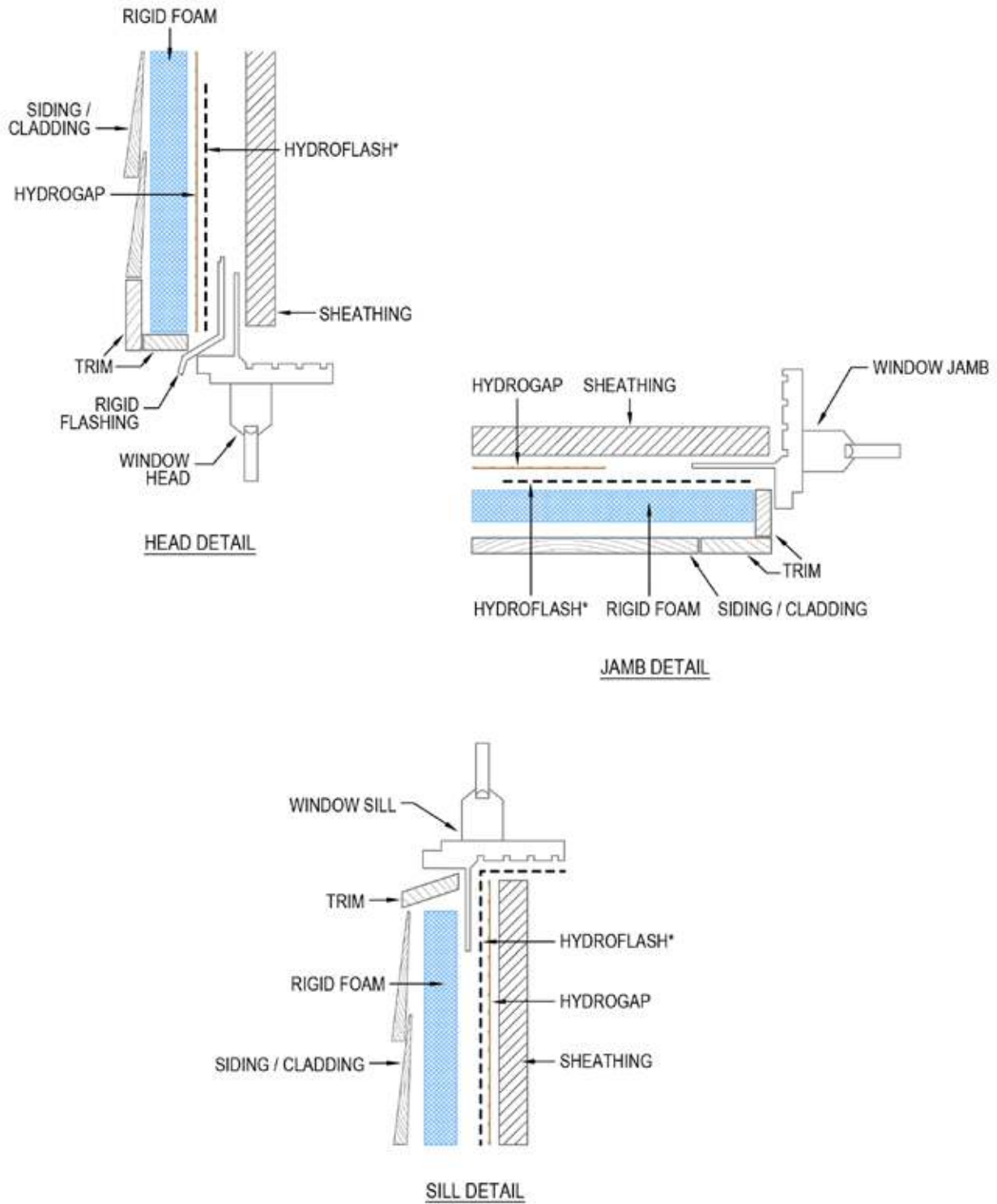

Rigid Foam Applications: Outie Window

